

Amptek Experimenter's XRF Kit

Quick Start and Demonstration

Amptek's Experimenter's XRF Kit contains the key components necessary to begin carrying out X-ray analyses. This kit was designed so users can rapidly set up a prototype XRF system and customize it for experiments and specific measurements. It is not a turn-key system because it has not been optimized or calibrated for specific applications; the user is responsible for optimization and calibration. This requires the user to understand both (a) the principles of XRF and (b) how to use Amptek's products. Once assembled and setup, the user is expected to initially acquire data and perform analyses using the "Expert Mode" of the included XRS-FP software, which presumes expertise in both topics. This guide will walk the user through the system set up and configuration, ultimately performing an initial example analysis ('standard-less') on a stainless-steel sample as a learning demonstration.

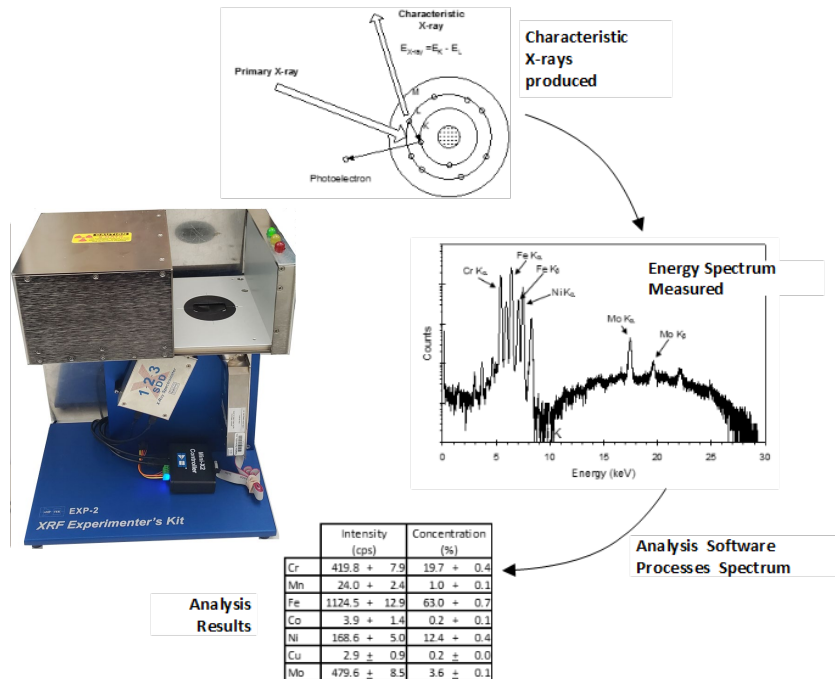

Warnings and Precautions



THE MINI-X2 GENERATES X-RAY RADIATION DURING NORMAL OPERATION AND PRESENTS A SAFETY HAZARD. The EXP-2 includes radiation shielding around the sample chamber, safety interlocks, and both visual and audio alarms. THE EXP-2 MUST BE ASSEMBLED CORRECTLY. DO NOT DISABLE OR TAMPER WITH ITS SAFETY FEATURES.



HIGH VOLTAGES ARE PRESENT IN THE MINI-X2 AND THE X-123. The Mini-X2 voltage (up to 50 kV) presents a potential personnel safety hazard.



THE DETECTOR AND X-RAY TUBE BOTH CONTAIN THIN, FRAGILE BERYLLIUM WINDOWS. If the windows are damaged, the units will be destroyed and cannot be repaired. Do not touch the windows! Do not drop anything on the windows! Be very careful when working around the detector!

THE USER MUST VERIFY THAT THE EXP-2 MEETS THE RADIATION REQUIREMENTS OF THEIR INSTITUTION. Warnings and precautions are discussed in more detail within the *Experimenter's Kit Application Notes*.

Release Note: This document (August 2019) describes the EXP-2 fixture, as used with an X123-SDD or X123-FastSDD, and with XRS-FP2. Earlier versions of XRS-FP, the fixture, or the X123 are not described here.

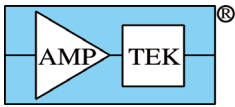

1. Equipment List

Amptek Supplied

- X-123 spectrometer. Includes X-ray detector, preamplifier, digital pulse processor & power supplies. It is mounted on a spacer. Amptek has many X-ray detector options. Recommended for the EXP-2 are the SDD or FastSDD options, with a 0.5 mil Be window.
- Mini-X2 X-ray tube and controller, with mounting bracket (attached).
- Mini-X2 collimator & filter kit for EXP-2
- EXP-2 mechanical fixture. Includes radiation shielding and sample plate.
- Six 4-40 screws

- Stainless steel (SS316) test sample
- 2 Mini-USB cables
- X-123 +5 VDC adapter
- Mini-X2 +12VDC adapter
- Amptek software installation CD or USB thumb drive
- XRS-FP USB HASP plug

Customer Supplied

- Computer with Win7 or Win10, and 3 USB ports
- Phillips screwdriver
- Optional: Safety secondary window (discussed below)

Documentation

The Experimenter's Kit combines three separate, standard Amptek products and a unique mechanical fixture. The components are (1) the X-123 spectrometer (which includes a detector and the DP5 digital signal processor), (2) the Mini-X2 X-ray tube (which includes a collimator with a place to mount filters), (3) XRS-FP2 X-ray analysis software, and (4) the EXP-2 mechanical fixture which provides radiation shielding, safety interlocks, and a sample chamber.

The X-123, Mini-X2, and XRS-FP2 are provided with extensive, separate documentation (quick start guides, user manuals, software installation guides, trouble-shooting guides, and application notes). These can all be found on the Amptek Installation CD or USB thumb drive and Amptek's website. The software has a HELP file with much information. Please refer to these documents to understand the individual components in the kit. This "Experimenter's Kit" document focuses on assembly and initial operations of the kit and does not discuss details on the various components.

2. Mechanical Assembly

The drawing to the right shows an assembled EXP-2 fixture. To assemble:

1. Place the EXP-2 fixture on its back for easy access. Make sure there is nothing inside the sample chamber (e.g. the sample support disk).
2. Install the cables onto the Mini-X2. There are four cables: power (to the +12V AC/DC adapter), USB, and a four-pin interlock cable, and a 10-pin ribbon cable.
3. The Mini-X2 has been shipped with its mounting bracket attached. Align with the holes in the fixture and attach with two ¼" long 4x40 screws. Plug the interlock cable into the fixture.
4. Install the cables onto the X-123. There are two cables: power (to the +5V AC/DC adapter) and USB. NOTE: The X123 and Mini-X2 power cords have the same style plug; they are not interchangeable in usage but will cause no damage if plugged into the wrong device.
5. The X-123 has been shipped with its baseplate attached. It also has a protective cap covering the Be window. This cap can remain over the detector throughout the assembly procedure and need be removed only when

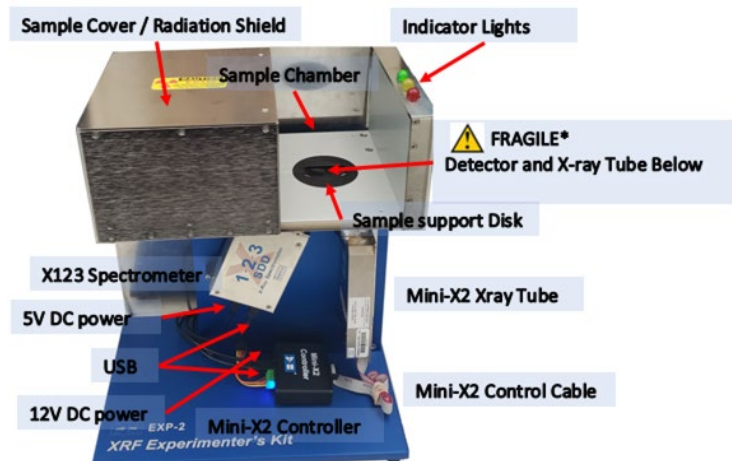

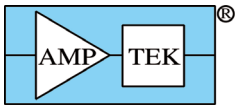

making measurements. Carefully slide the detector extension of the X-123 through the hole in the shielding at the base of the sample chamber. Attach the X-123 to the upright with four 1" long 4x40 screws.

6. BE VERY CAREFUL NOT TO TOUCH OR DROP ANYTHING ONTO THE DETECTOR BE WINDOW. Turn the fixture upright and install the Mini-X2 collimators and filters.
7. The Mini-X2 is shipped from Amptek with a bevel-edge collimator and solid copper insert installed. These two components must be removed and replaced with a collimator housing (picture below). The bevel edge collimator should be unscrewed and removed, along with the copper insert. These components should be put aside and saved (along with the other copper collimators) if the user desired to later experiment with different beam geometries.
8. This step can be done while the protective cover is still on the detector. Once the filters are in place, remove the cover. The provided collimator housing should be carefully threaded onto the Mini-X2. Place the tungsten collimator insert into the housing. In the Mini-X2 filter holder, first place a 1 mil tungsten filter and then on top of this place a 40-mil aluminum filter. These filters can be found in the Mini-X2 collimator kit. VERY CAREFULLY, slip the holder, with filters, over the collimator housing.



9. Place the sample mounting plate (the black plastic disk with a rectangular cutout) into the opening in the sample chamber. The user may wish to cover this with a safety secondary window. This is a thin polymer window to avoid accidental damage to, or contamination of, the detector Be window. Commercial sources and part numbers are in the Experimenter's Kit Application Notes.
10. Place the stainless steel 316 test sample over the cutout in the sample holder.
11. Slide close the cover of the sample chamber (the cover is vital for radiation shielding). Fully depress the interlock plunger behind the cover. The chamber and the plunger are a tight fit; it is necessary that the plunger be fully seated for the Mini-X2 X-ray tube to operate (even if the slide cover is prevented from moving).



Beryllium windows damaged by improper handling will not be covered by warranty

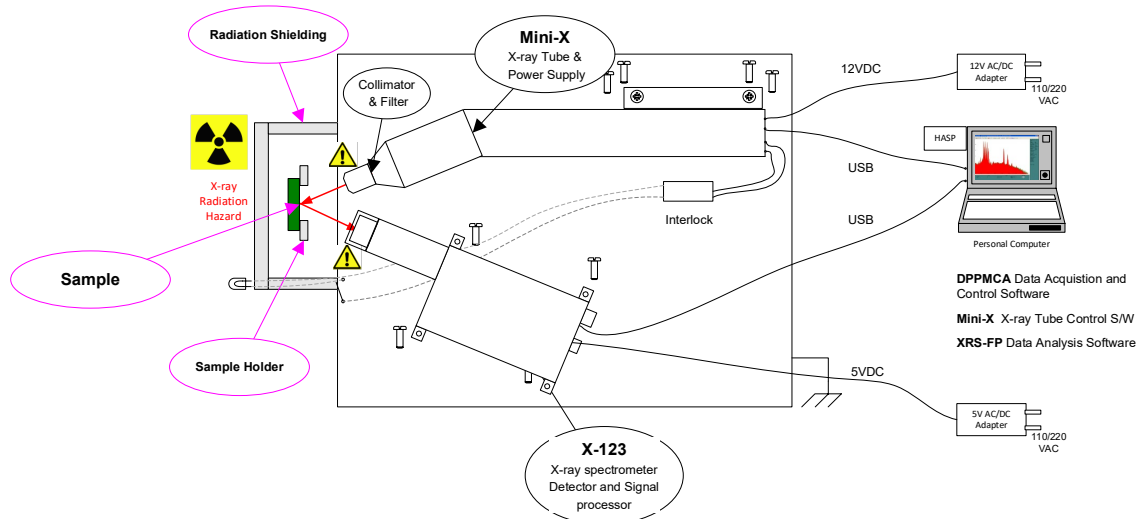

3. Connect Modules & Install Software

Three software packages are needed: “DPPMCA.EXE” is used to configure and acquire data with the X-123 spectrometer; “MiniX2.EXE” controls the Mini-X2 X-ray tube; and “XRS-FP2.EXE” provides a means of simultaneous control (of both the spectrometer and x-ray tube), along with data acquisition and analysis. Each of these software packages requires a USB driver to be loaded. THE USER MUST FOLLOW THE SOFTWARE INSTALLATION INSTRUCTIONS CAREFULLY.

For all these products, the first step is to power on the hardware and plug it into a USB port. The proper USB driver should be automatically downloaded from Microsoft’s Windows Update site and installed, if the computer has Internet access and updating is not blocked by a firewall or administrative settings. If automatic installation is blocked, then manual installation is required. The drivers and the executable programs, along with instructions for manual installation, are on the Amptek installation CD and available from www.amptek.com.

Connect X-123 and install DPPMCA Software and Drivers

1. Turn on the PC. Log on to Windows as an administrator. Insert the Amptek Installation CD, USB thumb drive or download the software from www.amptek.com.
2. Connect the X-123 to the PC via a Mini USB cable. Plug the X-123 5VDC supply into a 110/220 VAC outlet and into the X-123 back panel. An LED on the X123 Ethernet connector should light up.
3. A “Found New Hardware” or “Installing Device Driver” box may open, or an installing icon may appear on the taskbar (depending on the operating system). Automatic driver installation over Windows Update should follow; follow any instructions for automatic update and installation.
4. Create “C:\Program Files (x86)\Amptek\DPPMCA”. From the CD, copy the contents of “DPP Software (FW6)\DPPMCA” into the new folder. Create a shortcut to DPPMCA.EXE and place this on the desktop.

Install XRS-FP2 Analysis Software

1. Plug the XRS-FP2 HASP into the PC USB port.
2. A “Found New Hardware” or “Installing Device Driver” box opens; follow instructions for “Automatic” installation over Windows Update.
3. Locate the “XRF-FP2 Quantitative Analysis Software” folder on the Amptek Installation CD. Run (as administrator) the “XRSFP2_Setup.exe” file and follow the instructions.

Install Mini-X2 Software and Drivers

1. Connect the Mini-X2 to the Mini-X2 control box with the provided flex cable and connect the control box to the PC via a Mini USB Cable. Plug the Mini-X2 12 VDC supply into a 110/200 VAC outlet and into the Mini-X2 control box.

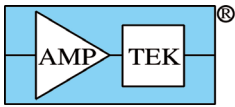

2. A “Found New Hardware” or “Installing Device Driver” box opens. Follow the instructions for “Automatic” installation over Windows Update.
3. Locate the “Mini-X2 Software/Mini-X2 Setup” folder on the Amptek Installation CD. Run (as administrator) the “Mini-X_Controller_Setup.exe” file and follow the instructions.

Quickstart Files

On the Amptek Installation CD or thumb drive is the *Experimenter's XRF Kit* folder. Copy “SS316_EXP1 default.ANA” from the appropriate folder into C:\Program Files (x86)\CrossRoads Scientific\XRS-FP2\.

When finished, if the driver installation was successful and the devices are powered, they will be visible as ‘DP5 Digital Pulse Processor’, ‘MiniX2 Controller’, and ‘Sentinel HL’ under Control Panel, Devices and Printers (or Windows Settings, Devices for Windows 10). Icons for the DppMCA, MiniX2Ctrl and XRS-FP2 software should now be present on the user desktop, connected to file locations on the user computer.

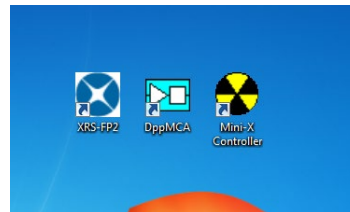
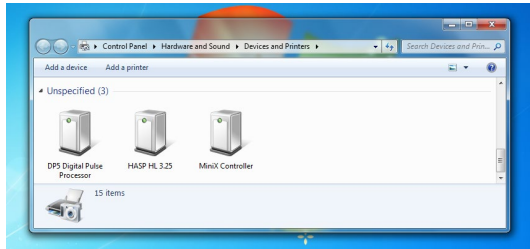

4. Check Hardware

Check X-123 spectrometer

1. Double-click “DPPMCA” icon. A “Select DPP Communications Port” dialog opens. The device should be listed in the USB section. Click “Connect”.
2. A green USB symbol should appear at the bottom and the DP5 serial number at top right.
3. Note: The X-123 boots up using the configuration stored internally when it was powered down. As shipped, the unit was last powered down using a configuration stored at the factory where it was tested with a ⁵⁵Fe radioisotopic source. This may need to be changed for other XRF applications.

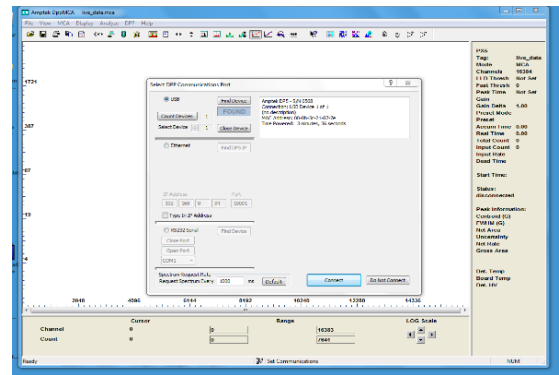

4. Note the toolbar along the top of the spectrum viewing window. Most of the basic MCA data acquisition functions can be reached through these icons. Try clicking the Start/Stop icon to acquire a spectrum, which at this point would be only noise since no radiation source should be present. The Delete Data icon clears the active spectrum and resets the acquisition time. A noise spectrum may appear with most counts towards the left end of the spectrum. If one clicks the Tune Thresholds icon while an acquisition is taking place, the DP5 will automatically adjust thresholds to negate (ignore) low energy counts (those on the left end) and the spectrum acquisition may become much cleaner. Further modifications to the DPP setup may need to be made (such as Gain Adjust) but will require the x-ray source to be ON in order to collect real x-ray counts. Another useful mode to become familiar with is MCA Delta Mode, which enables collection of repetitive 1 second data acquisitions. Often Delta Mode is used together with the Gain Adjust (either increase or decrease) to have the spectrum be fully viewable within the window.

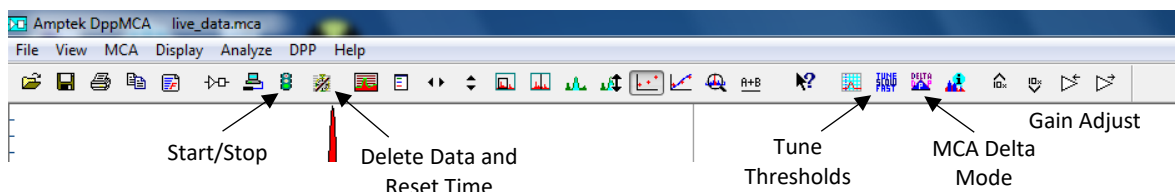

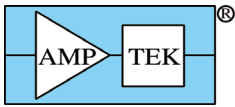

5. A representative noise spectrum is shown. Actual appearance may differ based upon DP5 settings and operating environment.

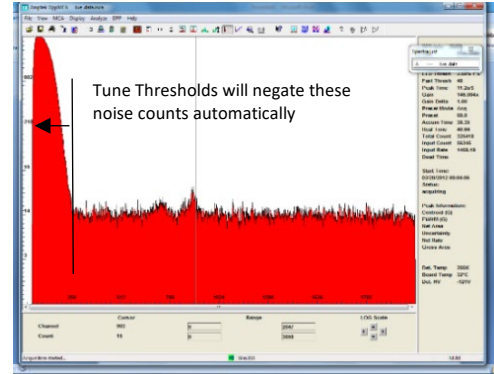

Check X-ray tube and shielding

1. Double click the “Mini-X2” icon on the desktop. Click “Start Mini-X”. The serial number should appear in the top middle and the “HV ON” and “OFF” boxes will become active.
2. Verify that the stainless-steel sample is inside the sample chamber and covering the opening of the support disk. Close the sliding cover on the sample chamber and fully depress the safety interlock plunger.

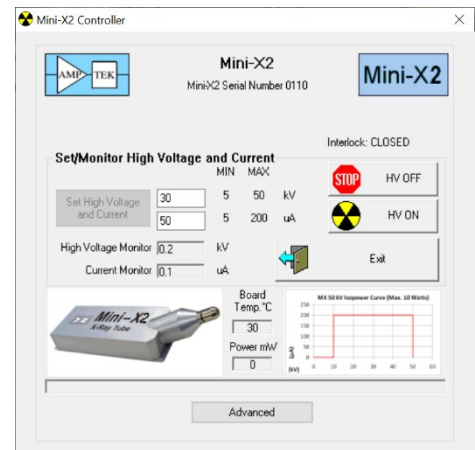

3. Note that the EXP-2 has three indicator LEDs connected to the operational status of the Mini-X2 X-ray tube. The green LED is illuminated when the X-ray controller has power. The yellow LED is illuminated when the interlocks are satisfied. The red LED will flash when the X-ray tube is producing radiation.
4. Verify that Mini-X2 software is set to 15 kV and 15 μ A (starting at a low level for safety).
5. In the Mini-X2 software, click “HV On”, then select “Yes” on the box that appears. The Mini-X2 should begin beeping along with the flashing red indicator LED, and a symbol will appear on screen.
6. Use a survey meter to verify that the shielding is effective, looking particularly for scattered X-rays.

Radiation safety check:

1. Increase the Mini-X HV setting to 50 kV (maximum) and the current to 80 or 200 μ A (whichever is the maximum). Again, use a survey meter to verify that the higher energy radiation is stopped by the shielding.
2. Finally, adjust the HV to 30 kV and the current to 100 μ A.



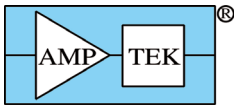

Check that X-rays are detected

Counts should be recorded in the spectrum. Click "Delta" to accumulate data, and the display should look like the screen on the right. The "Info Pane" (right) should show counts, fast and slow. The peaks visible here are the Cr, Fe, and Ni peaks in stainless steel.

If the screen looks like this image, and you are familiar with X-ray spectroscopy and settings, then

1. Click "HV Off" to turn off the tube.
2. Go to "Configure X-123 Spectrometer" on the next page.

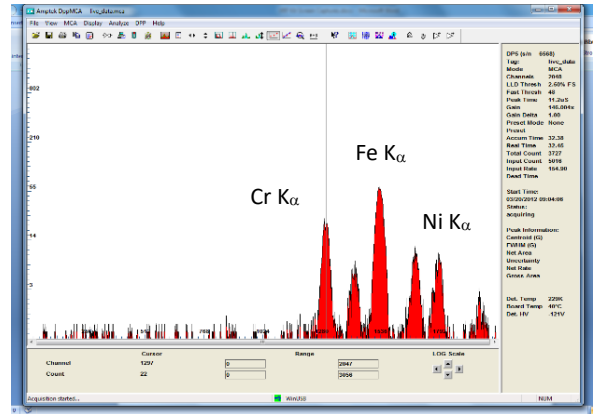

If the screen does not look like this, then

1. Confirm that the DPPMCA software is connected to the X123 – showing a green USB symbol at the bottom of the spectrum display and the info pane at right should show a connection to a DP5, with a serial number.
2. Click "HV Off" to turn off the X-ray tube. Now click the "Clear" button, then "Start/stop" to begin acquisition, then "Delta". Now click the "Tune Slow Fast" icon on the toolbar and wait while parameters are adjusted.

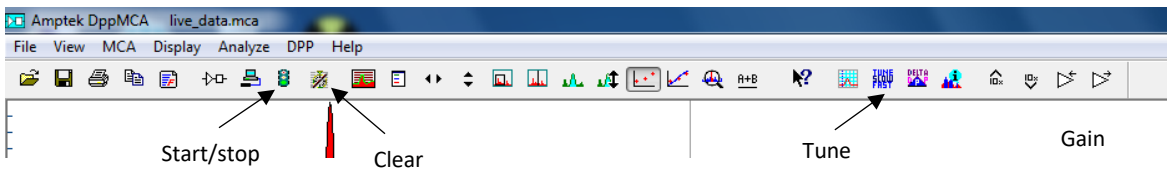

3. Click the "HV On" button to turn the tube back on. The spectrum should now look like that shown.
4. The gain may need to be adjusted using the two Gain Adjust buttons at the far-right end of the toolbar (one for Gain decrease, one for Gain increase).
5. If you still see nothing, make sure that the X-ray tube is on (the red light should be blinking). If the tube seems to be working and you see no spectrum, refer to the "Troubleshooting Guide for Amptek Digital Pulse Processors", located in the Documentation folder of your installation CD or USB thumb drive.

If you are completely new to X-ray spectroscopy, then

This is a convenient time to become familiar with X-ray spectra, with the parameters of the spectrometer, and with the parameters of the X-ray tube. Amptek recommends spending time familiarizing yourself. Some things to try:

- The "gain" is important. Try adjusting the gain, using the arrows, and observe the effect on the spectrum. It may be necessary to turn off the tube and tune the thresholds after adjusting the gain. Refer to the DPPMCA HELP, FAQ section, to read about Gain and Thresholds.
- Many novice users ask "How do I know which peak is which?" The answer is: "You must do an energy calibration, which is the next step in this procedure." But if measuring samples with known elements, major peaks can be readily identified. In SS316, Fe is the major element and correspondingly has the highest peak. Try a measurement with brass (mostly Cu and Zn), or something chrome plated. Observe the spectra. Gain may need to be decreased first.
- Trying adjusting the X-ray tube energy up and down and see the effect on the spectrum. Try adjusting the current up and down and see the effect on count rates.

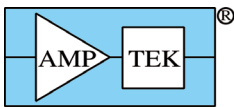

5. Configure X-123 Spectrometer

1. The configuration of the X-123 will need to be changed from the factory test configuration to one appropriate for this XRF application. In particular, the gain should be adjusted to give approximately 40 keV full scale. A gain of 30 - 35 is typical for an SDD, 7.5 to 8 for a FastSDD.
2. In DPPMCA, select the "Acquisition Setup" button, then the "Gain" tab. Set gain to 30, then click "Accept".
3. On the MCA tab, set the preset time to "30 seconds", set MCA channels to 2048, then click "OK".
4. With the X-ray tube OFF, click the "Tune Slow/Fast" icon
5. Verify that the HV is 30 kVp and the current 100 μ A. Turn the HV on, then turn "Delta mode" off. When data acquisition stops, click "HV OFF" button to turn off the X-ray tube. The spectrum should look like the one displayed below.

Calibrate the energy scale

To calibrate the energy scale, at least two peaks of known energy must be identified. For best results, use peaks that are widely separated in energy, with good statistics and no overlapping peaks. In this example, Amptek recommends using the Fe and Mo K_{α} peaks in stainless steel 316. What needs to be done is to mark regions of interest (ROIs) around the two peaks, open the calibration dialog, then define the energies of the centroids. The software performs a linear regression. The calibration obtained in DPPMCA will be transferred to the XRS-FP program.

Energy calibration is very important and can be a source of errors. For further information, refer to appropriate applications notes on the CD or USB thumb drive and to the DPPMCA Help topics.

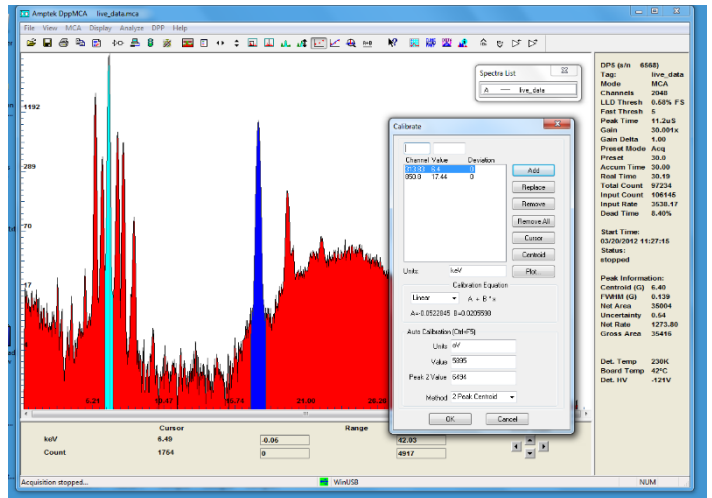

1. To mark the ROIs, click the "Edit ROI" button, then click, drag, and release for each peak. It is possible to zoom in on peaks for greater accuracy, using the arrows near the bottom of the display.
2. Click the "Calibrate" button. The dialog shown on the right appears.
3. Select the Fe K_{α} peak in the spectrum display, then click the "Centroid" button in the "calibrate dialog", then enter the energy (6.40 keV) in the box beside the channel. Click "Add".
4. Repeat for the Mo K_{α} peak at 17.44 keV. Click "OK", then "Enable Cal" on the toolbar.
5. Verify the calibration by checking the centroids of other peaks, e.g., the second largest peak (with SS316) is Cr K_{α} at 5.4 keV.
6. Check the energy resolution. The FWHM of the Fe K_{α} peak should be slightly larger than the FWHM listed on the data sheet supplied with the detector (e.g., about 140 eV).
7. Check if the upper channel (right hand edge) is about 40 keV. If not, then adjust the gain. You may use the ">" and "<" buttons on the toolbar and may find it convenient to turn on the tube and use "Delta Mode". The gain can also be changed using the "Gain" tab under "Acquisition Setup".
8. Under the "MCA" tab, set the "Preset time" to 30 sec. Advanced users should adjust other parameters at this time.

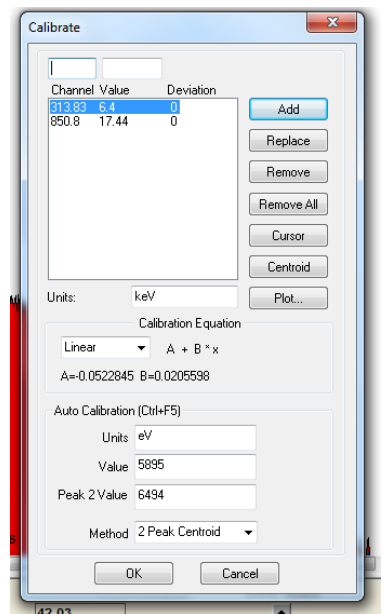

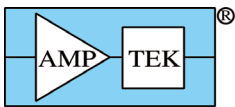

9. After all parameters are set, turn off the tube, clear the data, and start an acquisition with no counts. Click the "Tune Slow/Fast" button to set thresholds. Turn the X-ray tube back on and do a final energy calibration for the new settings.
10. If you have any questions about configurations or what you should see, you can refer to example MCA files (*.MCA) stored on the installation CD or USB thumb drive for your detector type and to the data sheet, showing a ⁵⁵Fe spectrum, which was supplied with your system.
11. Save the spectrum as an MCA file. Open the "Acquisition Setup" dialog, click "Save Configuration File", and save the configuration as DP5.TXT in C:\Program Files (x86)\CrossRoads Scientific\XRS-FP2\.
12. Close DPPMCA.EXE and MINI-X.EXE.

6. Configure XRS-FP Software

Properly configuring and calibrating the XRS-FP software is vital for obtaining accurate results. For the SS316 demonstration, you can start with existing configuration files appropriate for stainless steel and your detector. For other samples and measurements, care must be taken to properly configure and calibrate this software.

This "Quick Start Guide" will provide the key steps to doing a stainless-steel analysis with the EXP-2 Experimenter's Kit. For more information on the analysis software, refer to the "Basic Setup Tutorial" and the other tutorials. The overall flow of the analysis software, on page 4 of the setup guides, is particularly helpful. The tutorials can be found in the HELP section of the XRS-FP2 software or as PDFs in the XRS-FP2 folder.

Open the XRS-FP2 software. A splash screen will display briefly and then the home screen appears. The home screen for "Expert Mode" is shown to the right. As a quick overview to the software:

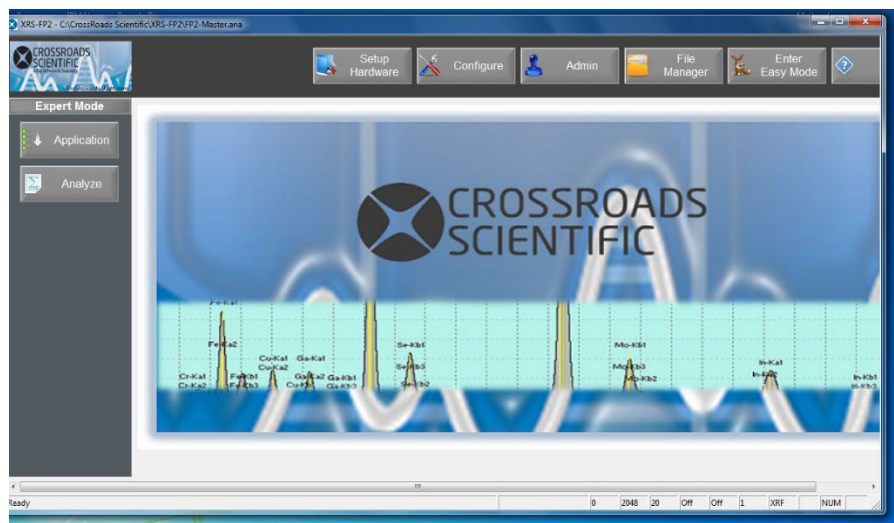

- Clicking the "CrossRoads Scientific" button in the upper left returns to this home screen.
- The "Setup Hardware" and "Configure" buttons define the instrument. The "Application" button defines the sample and the analysis methods. If one is testing different types of samples with one instrument, the "Application" parameters will be changed.
 - The "Setup Hardware" button connects the software to the X123 and the Mini-X2 and calibrates the energy scale of the X123.
 - The "Configure" button is used to tell the XRS-FP2 analysis software about the hardware setup (the detector, the source, the geometry, etc.).
 - The "Application", "Definition" buttons are used to define the sample, including elements to be analyzed.
 - The "Application", "Methods" button defines the parameters used to process the spectrum, methods used to fit the photopeaks, whether to use standardless or calibrated quantification, etc.
 - The "Analyze" button is used to acquire a spectrum and run an analysis, once setup, configuration, and definition are completed.
- "Expert" mode is needed to setup the hardware, configuration, and application. Once these are done, "Easy Mode" can be used to run routine analyses using the setup defined in "Expert Mode".

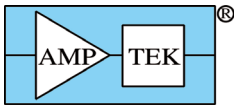

Set up the hardware

1. Select "File Manager" from then top ribbon, then select "Load" on the lower left. Locate the file "xxx SS316 Default.ANA" file provided by Amptek, where "xxx" refers to either "FastSDD" or "SDD", depending upon which model you have chosen. Click the green "Execute" button.
2. Select "Setup Hardware", then "DPP-MCA" button. Click the green "Connect" button on the upper right.

Note: The FP software compares its default parameters for the DPP with those in DP5.TXT, which you set using DPPMCA. This first time you connect, it will flag anything changed from its default; we expect the gain and thresholds to be different and others may change as well. Once you have saved a custom analysis file, then it will only generate a warning if you change parameters.

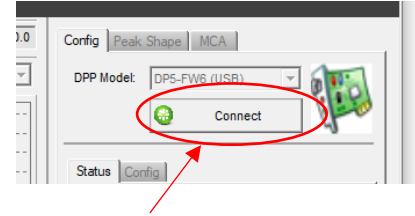

3. With the stainless-steel sample in the fixture, select the "X-ray source" button, then "HV On". It will check the interlock status, then ask "Turn X-ray HV on?" Select "Yes" and it power up in its default settings (15 kV and 15 μ A). Then select the green check "Apply" to bring up the settings for this analysis, 30 kV and 100 μ A.
4. Select "Acquire" to acquire a spectrum. You can see the elapsed Live Time (LT) increment and can see the measured input count rate (ICR) and output count rate (OCR). When it has finished, select the "HV Off" button.

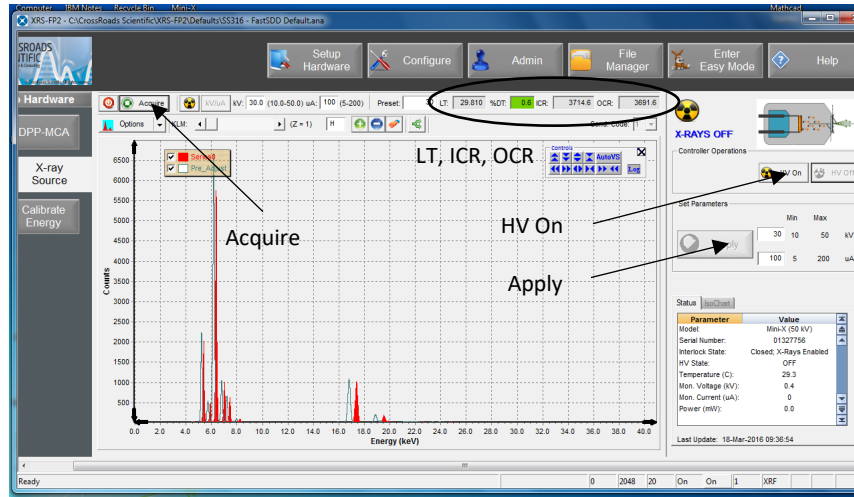

5. Select the "Calibrate Energy" button on the left (screen shown below) . If you adjusted the gain properly using DPPMCA, then you should be very close to 40 keV full scale and so only a small refinement to the calibration is needed. For a small refinement, verify that the "Theoretical peaks" are at 6.4 and 17.443 keV, using the Fe and Mo K_{α} peaks in the stainless steel 316 sample. Then select "Auto Calibration", then "Adjust Spectrum".

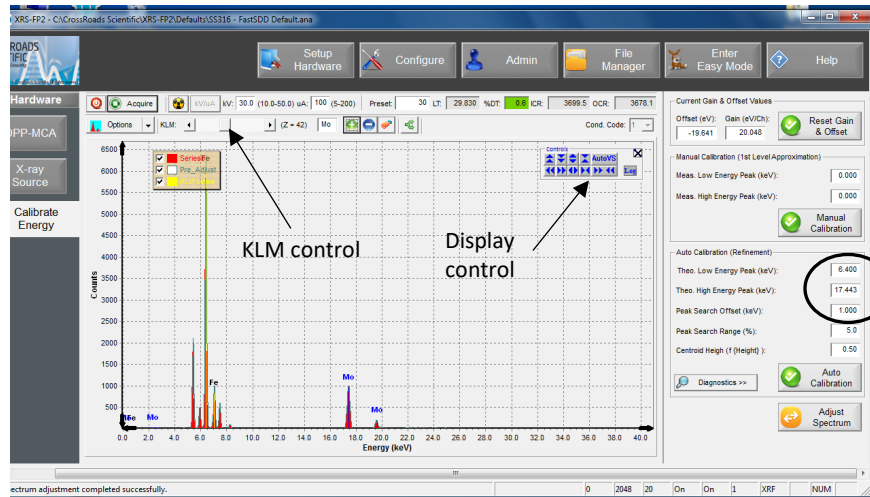
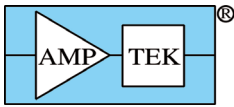

- Now you can use the Display control buttons to view the spectrum closely, zooming in on the peaks or using a log scale to see small peaks. You can use the “KLM” control to mark the X-ray peaks. Check the Fe and Mo peaks in particular; the lines should appear in the middle of the photopeaks.
- If the gain is not close (far from 40 keV full scale) or you are not calibrating with the Fe and Mo peaks in stainless steel, then select “Help” and refer to the “Basic Setup” and “Energy Calibration” tabs. Incorrect energy calibration is one of the most common sources of error for beginning users! Follow these steps carefully.

Check the configuration

- Select the “Configure” tab on the top banner. These values have been set to match the EXP-2 defaults but we recommend reviewing them now, for accuracy and to see what parameters are important.
- Select the “Detector” tab on the left. Select the “Edit” tab and you will see the default parameters for an Amptek detector (SDD or FastSDD). You may need to change the thickness of the Be window or the resolution to match your detector.
- Select the “Geometry” tab, then “Edit” to see all the parameters. There is an “Angles” tab and a “Distances” tab. If you modify the EXP-2 or use your own fixture, you will need to put in the corrected values.
- Select the “Source” tab, then “Edit” to see all the parameters. By default, this is set for Amptek’s silver anode Mini-X tube. If you are using something different, you will need to put in the corrected values.
- If you are using a detector filter, select the appropriate tab. We do not supply any with the EXP-2.
- Select the “Source Filters” tab. This defines the filter(s) used on the Mini-X. The “W3A197” item describes the default filter set recommended with the EXP-2, a 1 mil (25 micron) tungsten filter behind a 40 mil (1000 micron) aluminum filter. If you are using something different, enter “New”, put in the correct values, select “Calculate”, then click “Save”.
- Save the .ANA file, giving it a new name to reflect your customization.

Check the sample parameters

- Select the “Definition” tab to define the sample properties. The default has been configured for stainless steel, but it can be changed. To add an element, click the green plus, then select the element from the periodic table. The “layer table” is set for bulk analysis and to normalize the concentrations to 100%.

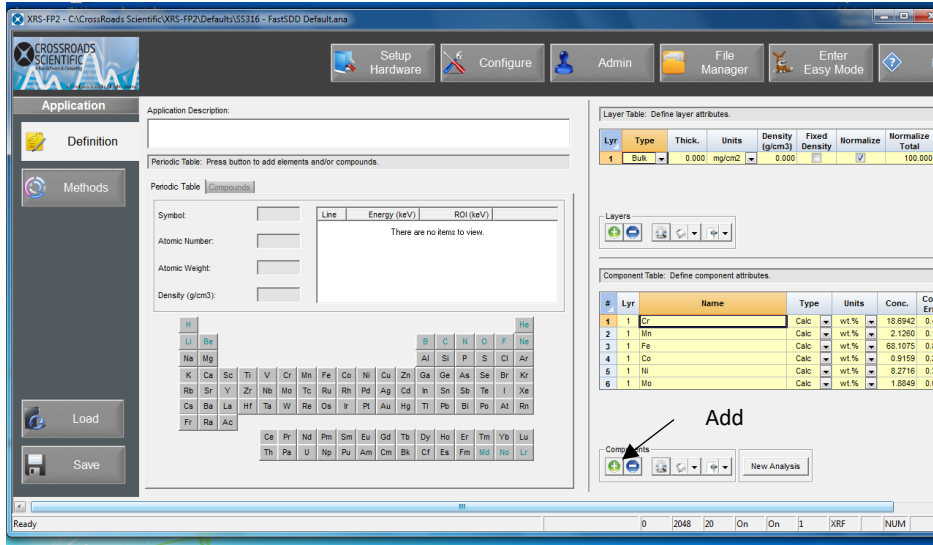
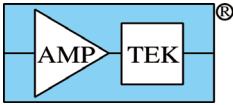

2. Select the “Methods” tab to review the parameters used in the analysis software. The “SS316_EXP1 default.ANA” file has recommended parameters for standardless analysis of the major constituents of steel. There are three key parts to the “Methods” used in the analysis

- Near the top of the page is the “Element Table”. For each element is a set of parameters defining how that element is analyzed: which lines is used for the analysis, the method used to determine the photopeak intensity, its region of interest, the method used to quantify the element, which excitation condition is applied.
- Near the bottom of the main screen is the “Condition Table” with different tabs defining the parameters used to process the spectrum, the step that determines the intensities of the characteristic X-ray lines. The “Measurement” tab defines the measurement properties assumed in the analysis. The “Process” tab defines the key process steps to be applied.
- On the right side of the screen are the “Quantification” settings, where one selects the calibration method: standardless, a single standard, or multiple standards. If calibration standards are selected, then additional buttons appear along the left, used in elemental calibration. This calibration refers to the relationship between the photopeak intensity and the corresponding element’s concentration and is completely different from the energy calibration discussed previously.

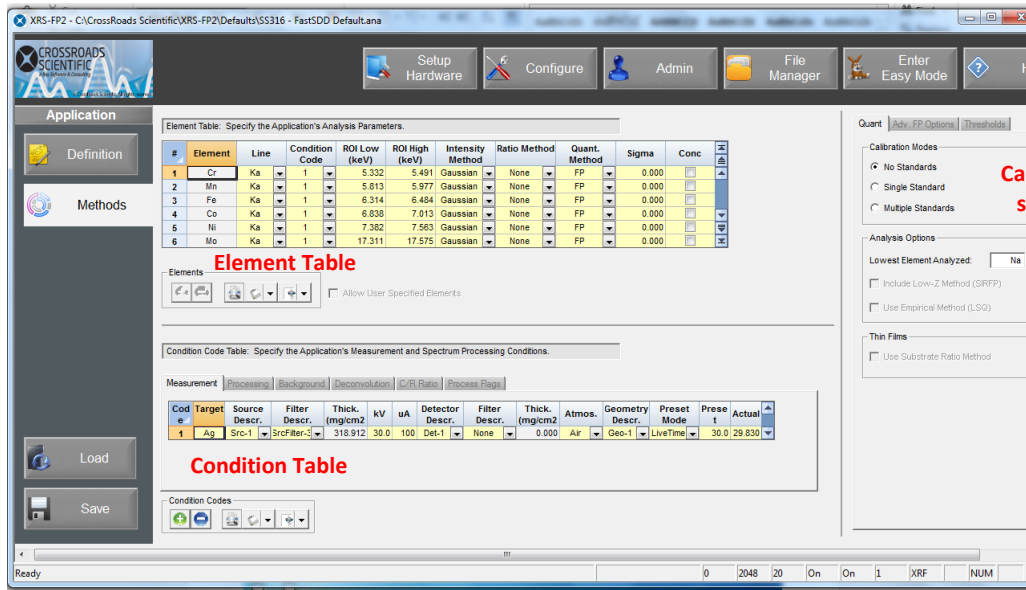

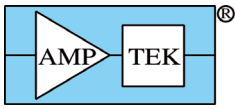

The system has now been assembled, set up, and configured for standardless analysis of stainless steel. We will now analyze the sample.

7. Acquire Sample Spectrum

Measure the spectrum to be analyzed

1. Click the “Home” button in the upper left, then the “Analyze” button along the left side.
2. Click the Mini-X icon, near the top left, to turn on the X-ray tube, then answer “Yes”. The “kV/uA” box is not grayed out when the tube is on. Wait for the current and voltage to stabilize.
3. Click the “Acquire” button. The spectrum will clear itself, then will appear and the time will increment. The spectrum will “Auto Adjust” along the energy scale, to be calibrated.
4. When the 30 seconds has elapsed and the acquisition is finished, click the Mini-X icon to turn off the X-ray tube.
5. You can zoom in to examine the photopeaks and to mark the X-ray lines using the KLM control.
6. You can verify here the input count rate (ICR), output count rate (OCR), and the key settings using the screens on the right.

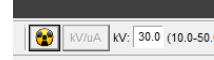

8. Process Spectrum

1. The next step is to process the spectrum. The software will correct for various physical effects (escape peaks and sum peaks), remove the background continuum, then will fit the selected photopeaks to remove the effect of overlapping peaks and to determine the intensity, or net counts, in each peak.
2. Select the “Quantify” button at the left side. If you now click the green “Execute” button, the software would go through all the processing steps quickly. In this demonstration, we will go step by step to observe what each is doing.
3. Select “Quantify Options”, then “Smooth.” Observe the result of smoothing in the spectrum window.
4. Select “Quantify Options”, then “Escape Peaks.” The software corrected for escape peaks; observe the result in the spectrum window. You can see both the corrected spectrum and the escape peak correction.
5. Select “Quantify Options”, then “Sum.” The software corrected for pileup by removing sum peaks; observe the result in the spectrum window. You can see both the corrected spectrum and the sum peak correction.
6. Select “Quantify Options”, then “Background Fit”, then “Background Subtract”. Observe the result in the spectrum window. You can see both the photopeaks and the background that was removed.
7. Select “Quantify Options”, then “Compton Peak”. Nothing is visible in the window but values were calculated.
8. Select “Quantify Options”, then “Deconvolute.” It may take many seconds but is fitting the peaks as a sum of Gaussians.
9. The “Results table” will show intensities: the rate of X-rays observed in each photopeak. This is the output of the processing step.

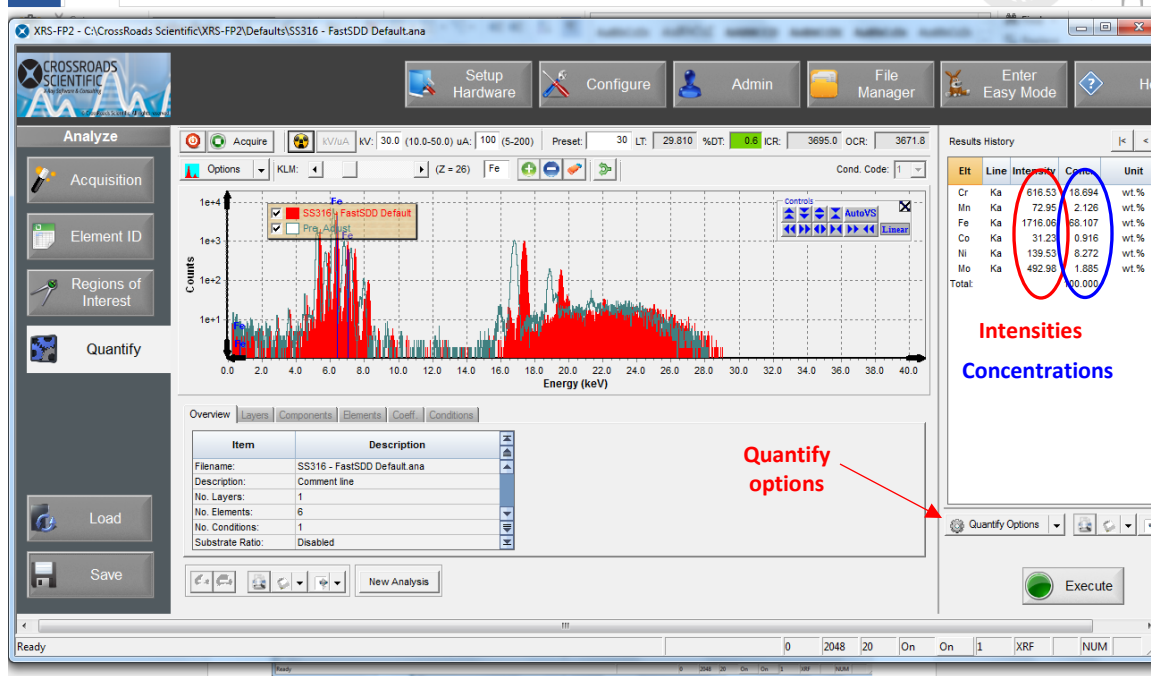
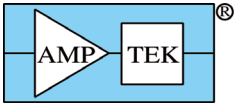

9. Analyze Intensities

1. Now click “Quantify Options”, then “Quantify.”. Using the intensities, the software applies corrections for matrix effects and attenuations and applies calibration factors to determine concentrations. Since this is a “standardless” analysis, the calibration factors are computed from theory rather than measured.
2. The result is shown in the “Concentration” column. By default, these are in units of weight % and have been normalized to 100%.
3. Print the report, then save the file. Enter a name for the sample, e.g., “Steel.ANA.” The .ANA is a CSV file (in ASCII) which can be read by Excel or Wordpad.

Congratulations! You have now set up the system and completed a standardless analysis.

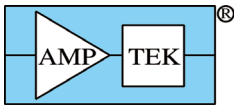

10. Next Steps

Now that you have carried out your first, standardless analysis of a metal alloy, what can you do now?

Easy Mode

So far, we have been using “Expert Mode”, which is used to set up, configure, and calibrate the instrument. Once this has been completed, “Easy Mode” can be used for routine acquisition and analysis. To use “Easy Mode”,

1. Select the “Home” button at upper left.
2. Select the “Enter Easy Mode” button at upper right.
3. The simplified screen shown to the right appears. To run an analysis, first use the “Load” button to recall the proper .ANA file, the one applicable to this instrument and sample.
4. Select the “Acquisition” button, then use the Mini-X icon and “Acquire” button to obtain a spectrum.
5. If needed, the “Calibrate Energy” button can be used to recalibrate the energy scale. Note that you will need to enter the energies of two peaks which are in your sample; this should be strong peaks (high concentration) and well separated in energy.
6. The “Element ID” button permits one to find if additional elements are present.
7. Select the “Quantify” button, then “Execute”, to perform the analysis as above.
8. Save the resulting .ANA file.

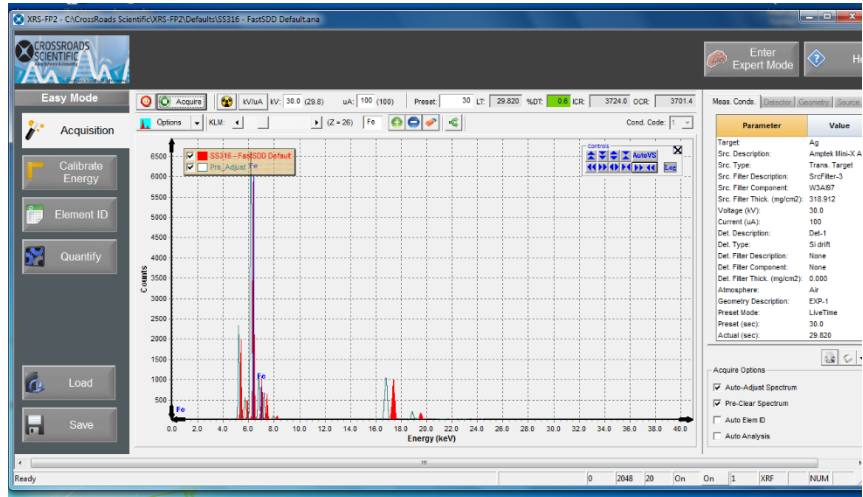

Optimize the configuration

It is very important that the configuration of the system be optimized for each particular application. This includes

- Optimizing the excitation source: the HV bias, the filtering, and the current are all important. Many novice users do not fully understand the important of the X-ray tube parameters, bias and filtering, in obtaining high quality results; these are very important.
- Optimizing the X-123: the gain, the peaking time, number of channels, and thresholds are very important. There are many other parameters, but these are the most vital.
- Optimizing the deconvolution parameters: the “Methods” tab gave access to many parameters which affect the accuracy and precision of the analysis results.

Calibrate the analysis parameters

This summary describes “standardless” analysis: the software uses simple models and nominal values to estimate the coefficients which relate the X-ray intensity to the concentrations. Much greater accuracy results are found by calibrating the analysis coefficients. These are calibrated from spectra measured using standards, reference materials of known compositions. Refer to the “Help” section of XRS-FP. The “Bulk Analysis” and “Standards Calibration” tutorials will be most helpful.

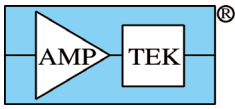

11. Learning More

The Installation CD or USB thumb drive contains a *Documentation* folder which includes user manuals, application notes, software installation guides, and much information describing the components in the Experimenter's Kit.

- The *DPPMCA* software's "Help" file includes detailed information on setting the parameters.
- The *XRS-FP* Software Guide provides detailed information on how to configure the analytical software.

For XRF novices, Amptek has a few application notes which may be helpful. These are all found on the "Links and PDFs" section of Amptek's web site.

- An X-ray emission line chart, showing the characteristic X-ray energies for each element
- A "Description of X-ray Fluorescence" and a note "Understanding characteristic X-rays"
- Three application notes showing the use of Amptek systems in EDXRF (one on RoHS/WEEE materials, one on light elements in water, one on used automotive catalytic converters)
- A note describing the processing software, "XRF spectra and analysis software".

Other references include

- *Principles and Practice of X-ray Spectrometric Analysis*, 2nd Ed, E.P. Bertin, Plenum Press, (1975).
- *Principles of Quantitative X-Ray Fluorescence Analysis*, R. Tertian, F. Claisse, Heyden & Son Ltd., (1982).
- *Handbook of X-Ray Spectrometry: Methods and Techniques*, eds. R. van Grieken, A. Markowicz, Marcel Dekker, (1993).
- *Quantitative X-ray Spectrometry*, 2nd Edition, R. Jenkins, R. Gould, D. Gedcke, Marcel Dekker (1995)
- *Handbook of Practical X-ray Fluorescence Analysis*, eds. B. Beckhoff, B. Kanngiesser, et al, Springer (2006)
- <http://xdb.lbl.gov/>

12. Frequently Asked Questions

Can I just use the default calibrations and settings?

No! There has been no calibration at Amptek. You should expect no meaningful results if you use the configuration in the X-123 when it shipped or the calibration values in the default files.

Is this XRF Experimenter's Kit comparable to a turn key XRF system?

No. This kit contains all of the critical hardware and software required to do energy dispersive X-ray fluorescence (EDXRF) but it is NOT a turn-key system. To get accurate results requires fabrication of radiation shielding and sample mount hardware, determining the optimum configuration of the hardware and software for your samples, and calibration. Obtaining quality results takes considerable effort.

A turn-key system is generally designed to handle a wide range of measurement applications. If a user has a specific application, particularly one that is challenging for turn-key systems, the Experiment's Kit lets the user optimize the entire system for that one application. It is a very powerful tool for specific and challenging measurement applications. But to obtain its advantages, the user must invest the time to fully optimize the hardware, the software, the calibration procedures, and so on.

A turn-key system is designed for an operator with minimal training. The operator turns on the system, takes a measurement, and the system gives the answer. The designers of the turn-key system have already optimized the configuration, calibrated the system, and evaluated its measurement uncertainty. The Experimenter's Kit requires a user to carry out these steps and to have the knowledge to carry them out.

Where do I turn if I am having a problem?

There is a "Troubleshooting Guide" in the documentation section of the Installation CD or USB thumb drive. You can refer to this or to the User Manuals for the various components.