

Digital Pulse Processor, MCA and Power Supply

PX5

Features

- Includes digital pulse shaping amplifier, MCA, and power supplies
- Compatible with all Amptek SDD, Si-PIN, and CdTe-diode detectors
- Supports detectors from other manufacturers, and both reset and feedback preamplifiers of either polarity
- Highly configurable
- Trapezoidal, and new Cusp shaping with wide range of peaking times to optimize performance
- High count rate capability with excellent baseline stability, throughput, and pile-up rejection
- Up to 8k output MCA channels
- Oscilloscope mode - DAC output for pulse monitoring and adjustment
- 8 single channel analyzer outputs

Communications

- Interfaces: RS-232, USB, Ethernet, I²C, auxiliary
- Software for PC data acquisition and control
- Software Developer's Kit included (SDK)

Power

- High voltage bias adjustable $\pm 100\text{V}$ to $\pm 1.5\text{ kV}$ (Higher voltages available as a custom option.)
- Thermoelectric cooler with feedback
- Operates from +5 V DC supply (AC power adapter included)

Overview

The Amptek PX5 interfaces between (1) an X-ray and gamma-ray detector with its preamplifier and (2) a computer running data acquisition and control software. Designed principally to support Amptek's XR100 series of SDD, Si-PIN, and CdTe detectors, it can be used with many other radiation detectors and preamplifiers, including HPGe detectors. It is compatible with both reset and feedback preamplifiers of either polarity. The PX5 includes (1) a high performance digital pulse processor (replacing a conventional shaping amplifier), (2) a multichannel analyzer, and (3) both low and high voltage power supplies (± 10).

The PX5 offers several advantages over traditional systems, including improved performance (very high resolution, reduced ballistic deficit, higher throughput, and enhanced stability), many more configuration options to optimize the system, and many communications and output options. The PX5 is based on Amptek's latest generation of digital pulse processing technology, also used in the DP5 family of products.

The PX5 is compatible with both 32 and 64 bit operating systems, including Windows 7.



Front



Back

Photograph of the front and back of the PX5

Applications

- X-ray and gamma ray detectors
- Nuclear Instrumentation
- Portable, battery operated systems
- OEM & Special Applications
- Process Control
- Research and Teaching

Amptek, Inc. 14 DeAngelo Drive, Bedford MA 01730

Tele: +1 781-275-2242 Fax: +1 781-275-3470 sales@amptek.com www.amptek.com

Specifications

Pulse Processing Performance	
Gain Settings	Combination of coarse and fine gain yields overall gain continuously adjustable from x0.75 to x516.
Coarse Gain	16 log spaced coarse gain settings from x0.75 to x413.
Fine Gain	Adjustable between 0.75 and 1.25, 10 bit resolution.
Full Scale	1000 mV input pulse @ x1 gain.
Gain Stability	<30 ppm/°C (typical)
ADC Clock Rate	20 or 80 MHz, 12 bit ADC
Pulse Shape - Trapezoidal or Cusp	Semi-Gaussian amplifier with shaping time τ has a peaking time of 2.4τ and is comparable in performance with the trapezoidal shape of the same peaking time.
Peaking Times	30 software selectable peaking times between 0.1 and 102 μ s, corresponding to semi-Gaussian shaping times of 0.04 to 42.5 μ s.
Flat Top Times	16 software selectable values for each peaking time (depends on the peaking time), >0.05 μ s.
Max Count Rate	With a peaking time of 0.2 μ s, 4 MHz periodic signal can be acquired.
Dead Time Per Pulse	1.05x peaking time. No conversion time.
Fast Channel Pulse Pair Resolving Time	120 ns
Pile-Up Reject	Pulses separated by more than the fast channel resolving time, 120 ns, and less than 1.05x peaking time are rejected.
Baseline Restoration - Asymmetric	16 software selectable slew rate settings.
Rise Time Discriminator (RTD)	The dpp can be programmed to select input pulses based on their rise time properties.
MCA Performance	
Number of channels	Commandable to 256, 512, 1k, 2k, 4k, or 8k channels.
Bytes per channel	3 bytes (24 bits), 16.7 M counts.
Preset Acquisition Time	10 ms to 466 days.
Data Transfer Time	USB: 1k channels in 12 ms; RS-232: 280 ms
Conversion Time	None
Presets	Time, total counts, counts in an ROI, counts in a channel.
MCS Timebase	10 ms/channel to 300 s/channel
External MCA Controls - Gate Input	Pulses accepted only when gated on by external logic. Input can be active high or active low.
Counters	Slow channel events accepted by MCA. Incoming counts (fast channel counts above threshold), event rejected by selection logic, and external event counter.
Hardware	
Microprocessor	Silicon Labs 8051F340 8051-compatible core.
External Memory	512 kb low-power SRAM
Firmware	Signal processing is programmed via firmware, can be upgraded in the field.
Communications	
RS-232	Standard serial interface, 115 or 56 Kbaud.
USB	Standard 2.0 full speed (12 Mbps).
Ethernet	Standard 10base-T.

Connections	
Analog Input (BNC)	The analog input accepts positive or negative going pulses from a charge sensitive preamplifier.
Power	+5 VDC. Mates with a center positive 5.5 mm x 2.1 mm power plug.
USB	Standard USB mini-b jack.
Ethernet	Standard Ethernet jack.
AUX-1 (BNC)	Configured in software as (1) an analog output, to view shaped pulses or diagnostic signals, (2) a digital output, to view a discriminator output or diagnostic signals, or (3) a digital input.
AUX-2 (BNC)	Configured in software as (1) a digital output, to view a discriminator output or diagnostic signals, or (2) a digital input, to gate or synchronize data acquisition.
AUX-3 (BNC) (15 pin D connector female)	Includes: (a) the lines for a serial RS232 interface, (b) two lines which can be configured for digital inputs or outputs, (c) 8 single channel analyzer (SCA) outputs, (d) a control line to command the power on or off remotely.
XR100 POWER: 6-PIN LEMO CONNECTOR	
1	Temperature
2	Bias (up to ± 1500 V)
3	-8.5 or -5 VDC
4	+8.5 or +5 VDC
5	Cooler - (grounded)
6	Cooler +
Ground on Shield	
Power	
+5 V	+5 VDC at 500 mA (2.5 W) typical. Current depends strongly on T_{det} , ranging from 300 to 800 mA at 5 VDC.
Input Range	+4 V to +5.5 V (0.4 to 0.7 A typical)
Initial Transient	2 A for < 100 ns
Auxiliary Inputs and Outputs	
The connectors bring out logic signals which are not required for the primary use of the PX5: acquiring spectra and transmitting them over the serial interface. These are generally "low level" logic signals associated with each pulse processed by the PX5; used for synchronizing the PX5 data acquisition to external hardware and for direct counter/timer outputs from the PX5. The signals are described below.	
Single Channel Analyzers	8 SCAs, independent software selectable LLDs and ULDs, LVCMOS (3.3 V) level (TTL compatible).
Digital Outputs	2 independent outputs, software selectable between 8 settings including INCOMING_COUNT, PILEUP, MCS_TIMEBASE, etc. LVCMOS (3.3V) levels (TTL compatible).
Digital Inputs	2 independent inputs, software selectable for MCA_GATE, EXTERNAL_COUNTER.
DAC Output	Used in oscilloscope mode to view the shaped pulse and other diagnostic signals. Range: 0 to 1 V.
Digital Oscilloscope	Displays oscilloscope traces on the computer. Software selectable to show shaped output, ADC input, etc., to assist in debugging or optimizing configurations.

Software

DPPMCA data acquisition, display, and control software is included. Also available for download and updates on Amptek's Software Download page.

- Full control of all hardware features, including acquisition presets, gain, peaking time, detector HV, detector temperature, number of channels, risetime discrimination parameters, and many more.
- Live display of the spectrum with many options. Can show up to 8k channels, with either integrating or delta mode. Includes linear and logarithmic vertical scaling, manual or auto-ranging, and zoom on the horizontal scale. Displays live spectrum and multiple stored or processed spectra.
- Spectral analysis features include energy calibration, setting regions of interest (ROI), computing ROI information (centroid, total area, net area, FWHM), spectrum smoothing, summing of spectra, subtraction and scaling of background spectra.
- Active link to the XRF-FP Quantitative Analysis Software Package using fundamental parameters, which can be purchased separately.
- Supports Microsoft Windows XP, Vista, and Windows 7.

For users wishing to write custom software, a software developer's kit is available.

General and Environmental

Operating Temperature	-40 °C to +85 °C.
Warranty Period	1 year
Typical Device Lifetime	5 to 10 years, depending on use
Long-term Storage	10+ years in dry environment
Typical Storage and Shipping	-40 °C to +85 °C, 10 to 90% humidity non-condensing
Compliance	RoHS Compliant
	TUV Certification Certificate #: CU 72072412 01 Tested to: UL 61010-1: 2004 R7 .05 CAN/CSA-C22.2 61010-1: 2004

Physical

Size	6.5" x 5.5" x 1.5" / 165 x 135 x 40 mm
Weight	1.6 lbs / 750 g

Digital I/O: 15 pin D connector (female)

1	Ground
2	RS232-TX
3	RS232-RX
4	SCA 6 Out
5	SCA 5 Out
6	Ground
7	Aux 3
8	Aux 4
9	SCA 8 Out
10	External Power On
11	SCA 7 Out
12	SCA 1 Out
13	SCA 2 Out
14	SCA 3 Out
15	SCA 4 Out



PX5 Waveforms

PX5 waveforms, showing from the preamp output to the shaped pulse etc.

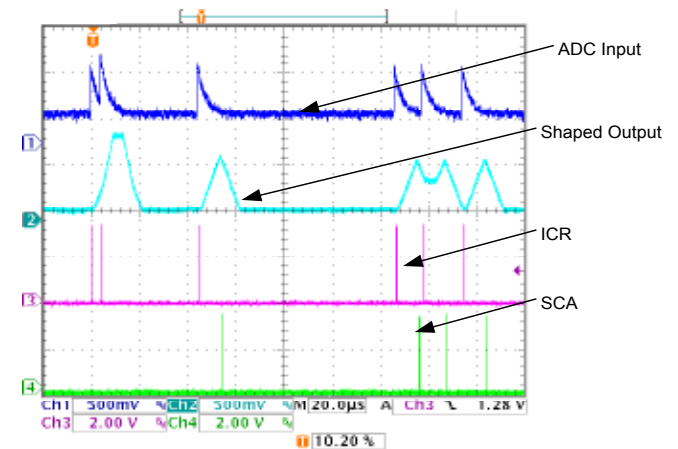
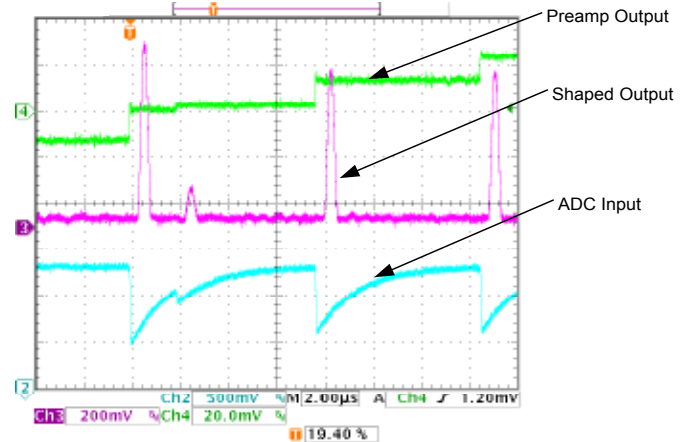

PX5 cusp waveform

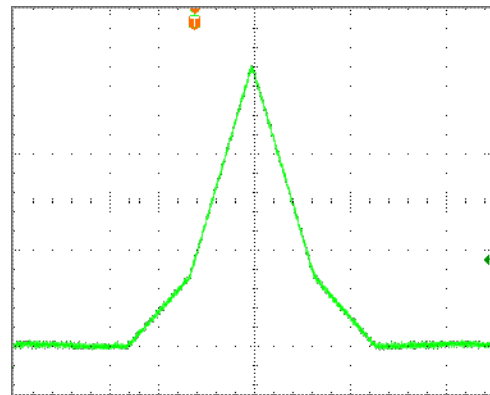

The PX5 complete pulse processing system and power supply

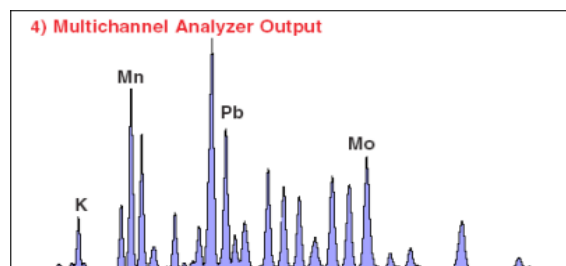
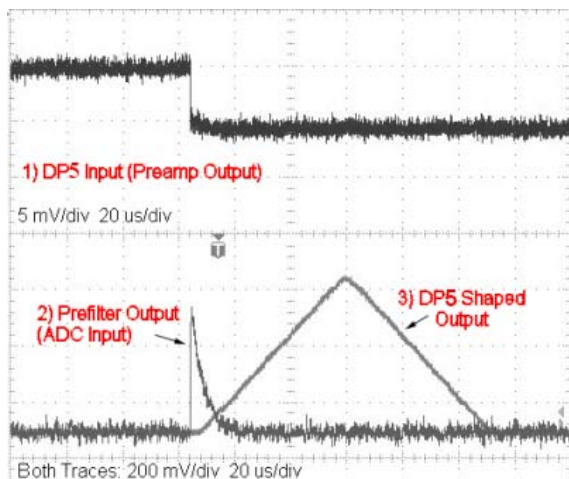

1. Digitizes the preamp signal
2. Implements trapezoidal shaping
3. Creates a multichannel analyzer (MCA) type output spectrum
4. Provides all necessary power for Amptek XR100 detectors.

PX5 Throughput vs. Peaking Time

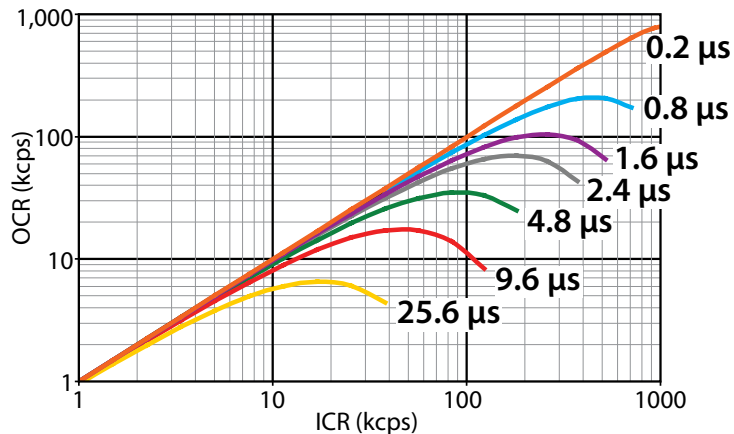

Complete XRF System Includes

- XR-100CR X-Ray Detector
- PX5 Digital Pulse Processor, MCA and Power Supply
- Mini-X USB Controlled X-Ray Tube
- XRF-FP Quantitative Analysis Software

Block Diagram

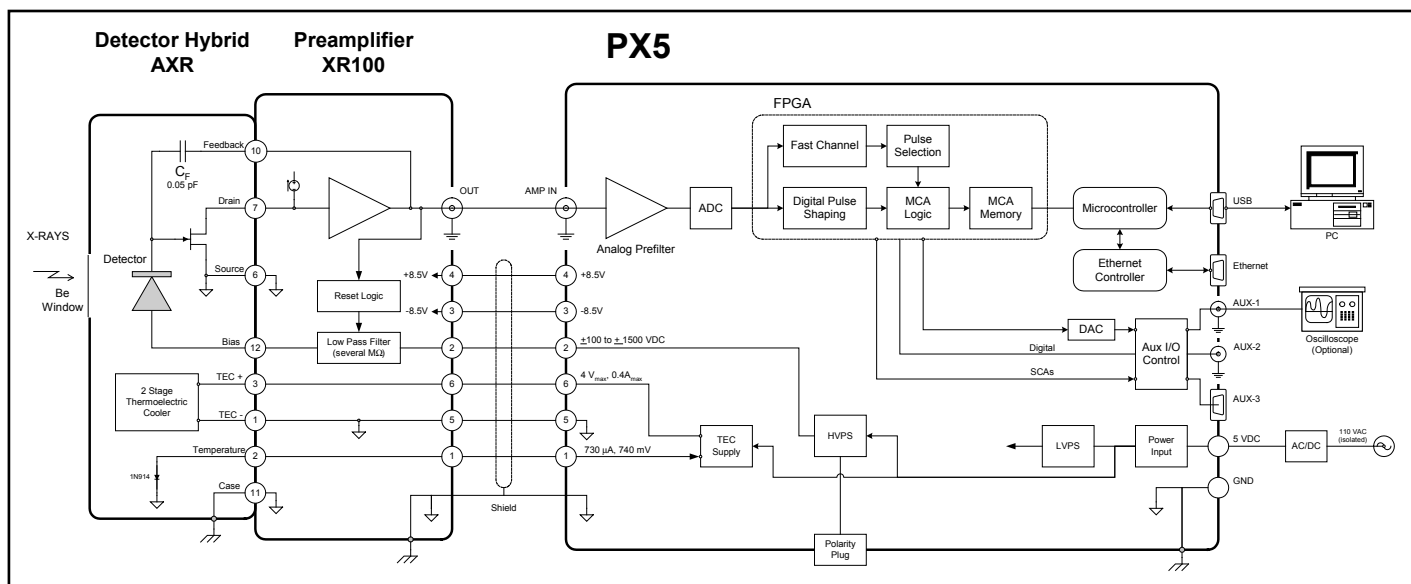

Block diagram of a typical system using the PX5 and an Amptek XR100SDD detector. Several different detector and preamp configurations are available from Amptek, Inc., with different pinouts and voltages.



Amptek, Inc. 14 DeAngelo Drive, Bedford MA 01730

Tele: +1 781-275-2242 Fax: +1 781-275-3470 sales@amptek.com www.amptek.com