

X-RAY GENERATOR WITH PYROELECTRIC CRYSTAL

COOL-X

Miniature X-Ray Generator with Pyroelectric Crystal Battery Operated

APPLICATIONS

- Portable X-Ray Instrumentation
- Teaching Laboratories
- Instrument Calibration
- Radiography (X-Ray Film Imaging)
- Research

FEATURES

- Miniature size - 0.6" dia x 0.4" / 15 mm dia x 10 mm
- Low Power: <300 mW
- Runs on a standard 9 V battery
- Variable end point energy: up to 35 kV
- Peak X-Ray flux: 10^8 photons per second (equivalent to a 2 mCi source)
- Solid state: Pyroelectric Crystal
- No radioactive sources

The COOL-X is a novel, miniature X-ray generator which uses a pyroelectric crystal to generate energetic electrons that produce X-rays in the target material (Cu). The hermetically sealed package has a thin beryllium window which allows the X-rays to be transmitted. The COOL-X does not use radioisotopes or high power X-ray tubes. It is a self contained, solid state system which generates X-rays when the crystal is thermally cycled.

The COOL-X is unique, and should not be compared with other X-ray tubes. It is thermally cycled between 2 to 5 minutes, and does *not* produce a constant flux of X-rays. The X-ray flux varies throughout the cycle and may vary from cycle to cycle, see Figure 4.

The use of the COOL-X in practical applications will challenge the user's imagination!

2003 WINNER



World's Smallest

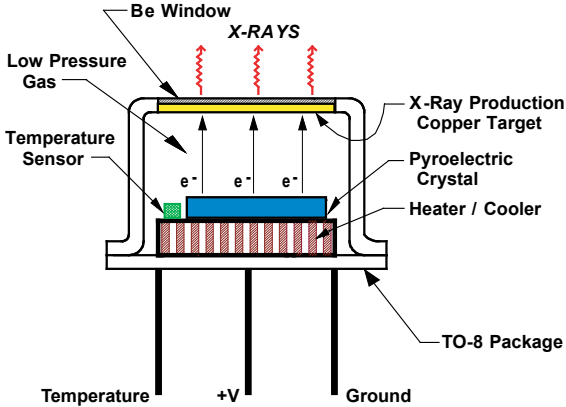

COOL-X Output Spectrum from Cu Target

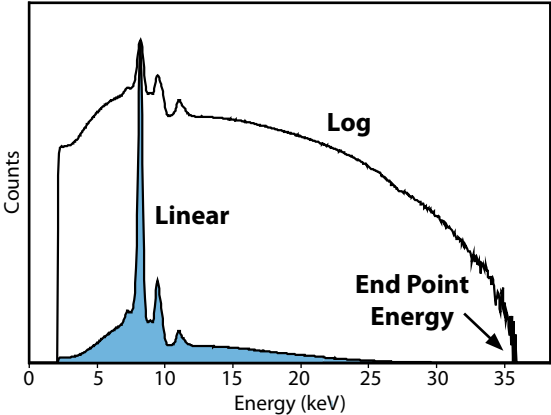

Theory of Operation

When heated, a pyroelectric crystal exhibits spontaneous decrease of polarization. Hence, as the temperature increases, an electric field develops across the crystal. For a specific crystal orientation (-Z face pointing to the target), the top surface of the crystal gets positively charged and attracts electrons from the low pressure gas in the environment. As the electrons impinge on the surface of the crystal they produce characteristic x-rays (Ta) as well as bremsstrahlung x-rays (see Figure 1).

When the cooling phase starts, the spontaneous polarization increases, and the electrons from the top surface of the crystal are accelerated towards the Cu target which is at ground potential. At this part of the cycle Cu characteristic x-rays are produced, as well as bremsstrahlung x-rays (see Figure 2). When the crystal temperature reaches its low point, the heating phase starts again. The cycle time of the COOL-X can be varied from 2 to 5 minutes.

Figure 3 shows the typical x-ray spectrum of the COOL-X obtained from the sum of 300 cycles with the dominant 8 keV peak and the bremsstrahlung continuum. Figure 4 shows a typical COOL-X output count-rate as a function of time for several heating and cooling phases. The X-ray flux varies throughout the cycle and may vary from cycle to cycle (see Figure 4).

Ref: J.D. Brownridge and S. Raboy "Investigations of pyroelectric generation of X-rays" Journal of Applied Physics, Vol. 86, No. 1, 1 July 1999

Figure 1: Heating Phase Spectrum

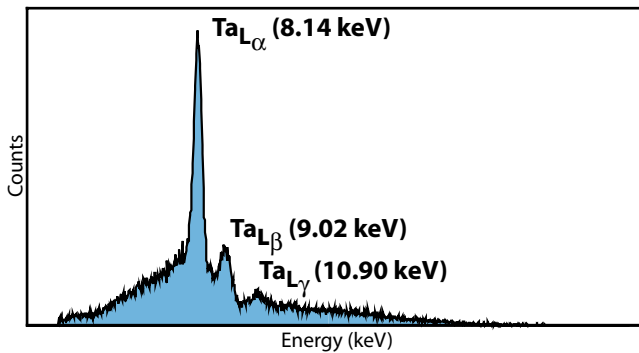

Figure 2: Cooling Phase Spectrum

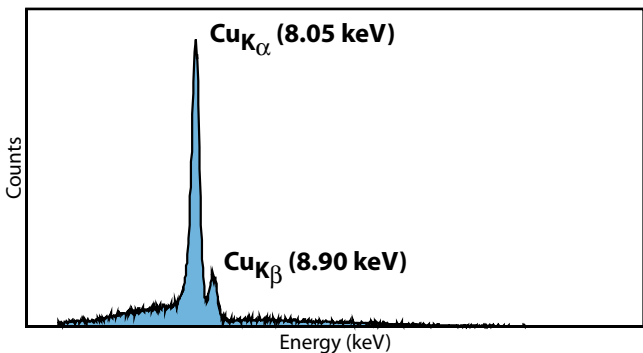

Figure 3: Combined Output Spectrum
(Heat & Cool, 300 cycles)

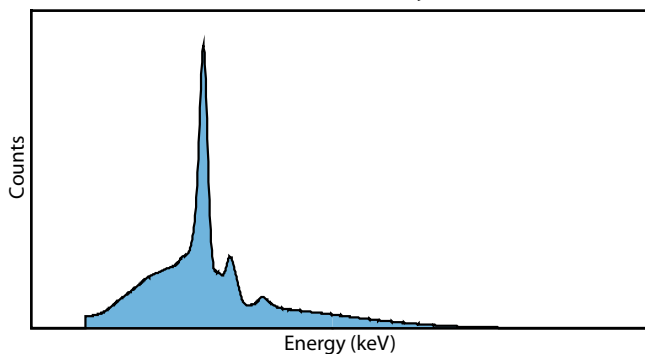

Figure 4: Heat and Cool Output Flux

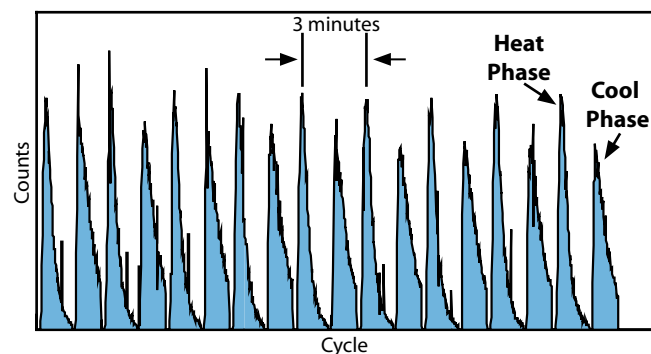
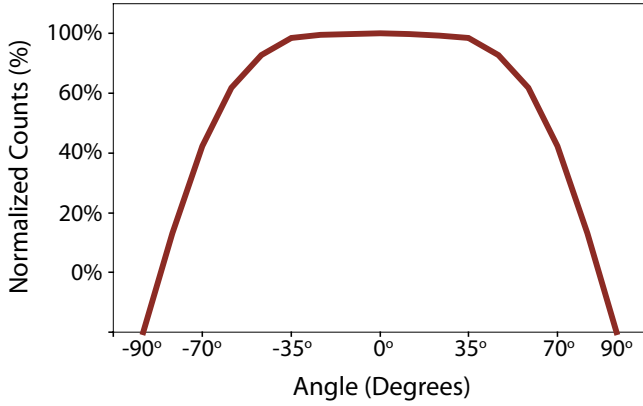
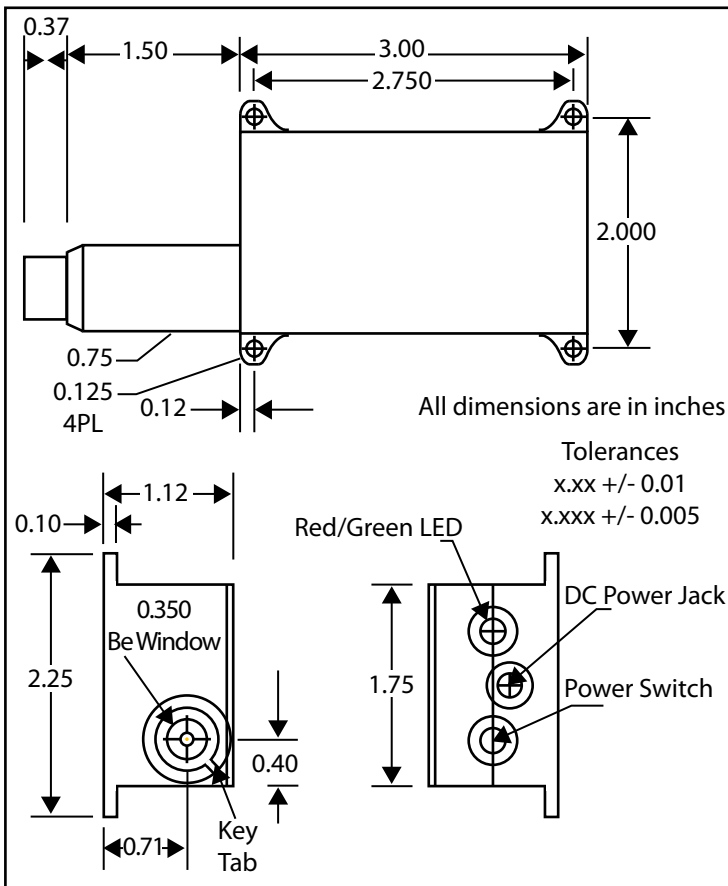

Figure 4 is a typical COOL-X output flux vs Time. Specific units may have more counts during the heating phase, or all of the counts in one of the two phases.

Typical Forward Output Flux vs. Angle



Mechanical Dimensions



XRF Applications

Multi-Element Fluorescence

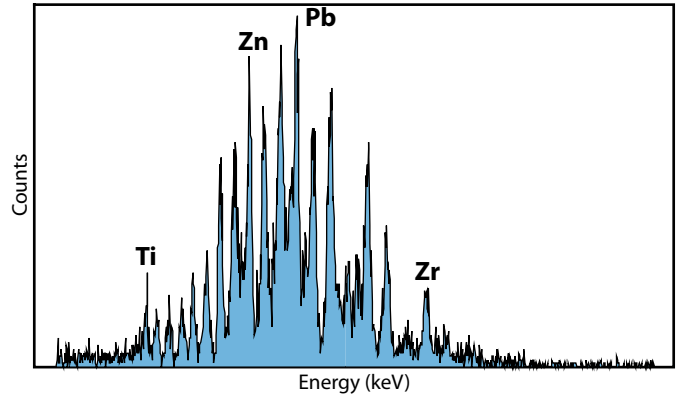

Lead (Pb) Fluorescence

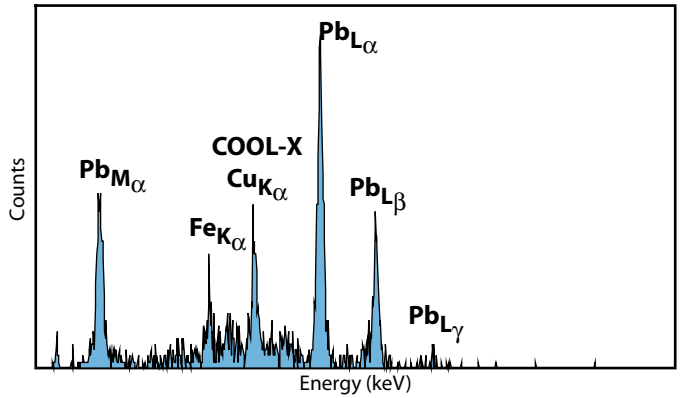

Aluminum Alloy Fluorescence

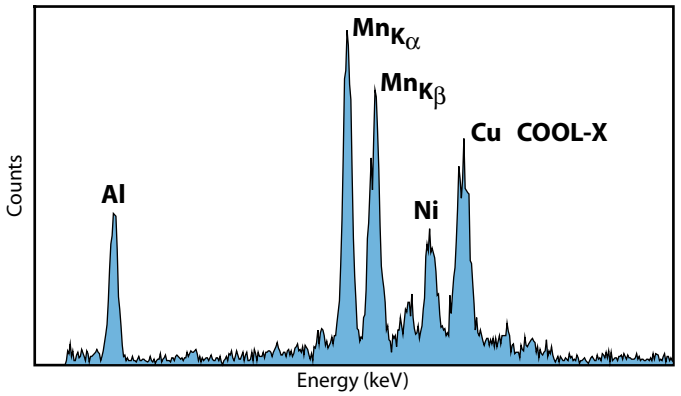

COOL-X shown with the Amptek XR-100CR X-Ray Detector in an XRF application



COOL-X Controller System

The Controller is enclosed inside the metal box. The function of the Controller is to supply power to the X-ray generator, monitor its temperature, and automatically change the heating and cooling phases of the cycle. Both a 9 V AC adapter and a 9 V battery are included. The battery will provide approximately 6 hours of operation.

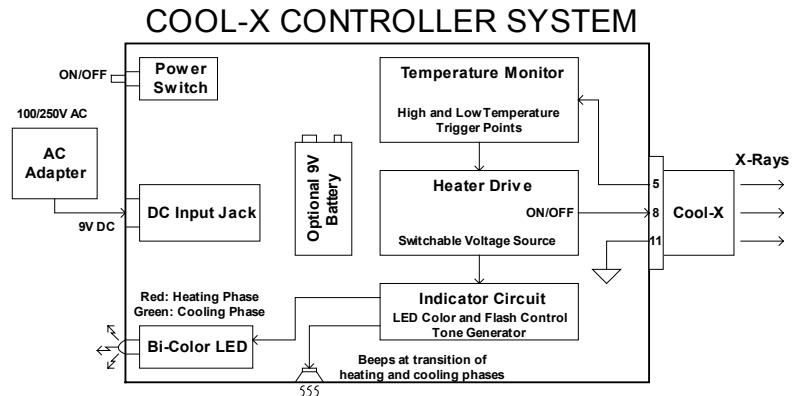
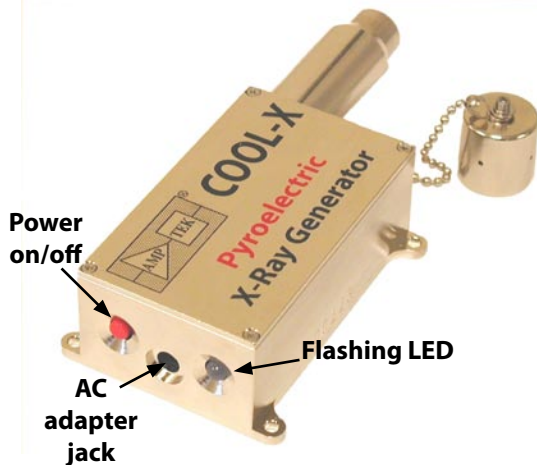

COOL-X Operation from a 2.5 to 4.5 Volts DC Supply

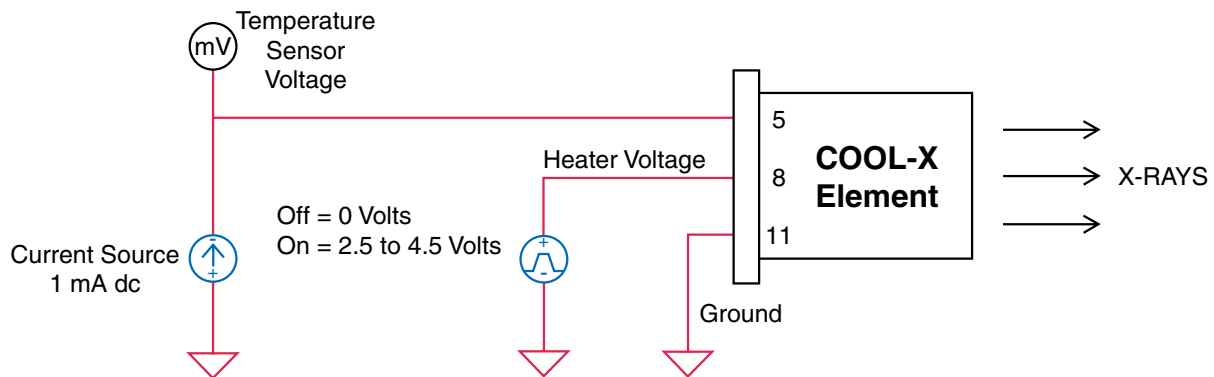

Lifetime of the COOL-X

When not in use, power to the COOL-X should be turned OFF. The COOL-X is not designed for continuous operation, therefore its lifetime will depend on how it is used.

If used intermittently, for about 1-3 hours per day, the estimated lifetime of the COOL-X can be extended to well over 1000 hours. Continuous use of the COOL-X will shorten its lifetime to approximately 200 hours.

Radiation Precautions

The COOL-X is intended to generate x-ray radiation during normal operation. Radiation from all directions is possible and should be addressed with shielding and/or monitoring in the final application. To be operated only by qualified personnel.

The maximum radiation at the peak of the heating or cooling cycle, at a distance of 10 cm is approximately 5 mSv/hr (500 mR/hr). The peak counting rate at a distance of 10 cm is approximately 200,000 counts/cm²/s. Approximately 75% of these x-rays are low energy below 10 keV.

Caution

The COOL-X is only one component of an X-ray instrument. It is the responsibility of the user, the OEM customer, or experimenter to provide a fail safe metal enclosure to prevent escaping radiation while using this product. The final product (turn-key system) must comply with local government regulations to protect personnel from exposure to radiation. Amptek Inc., bears no responsibility for the incorrect use of this product.

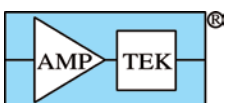

AMPTEK INC. 14 DEANGELO DRIVE, BEDFORD, MA 01730-2204 U.S.A.

Tel: +1 (781) 275-2242 Fax: +1 (781) 275-3470 email: sales@amptek.com www.amptek.com